

MITYLITE®

伊马拉移动酒吧



规格

高度: 47.25英寸 (120.02厘米)

宽度: 32.75英寸 (83.19厘米)

长度: 72英寸 (182.88厘米)

重量: 475磅 (215.46公斤)

吧台台面深度: 30英寸 (76.20厘米)

吧台台面材料: Thinscape, 紧凑型层压板

吧台顶部回位宽度: 7英寸 (17.78厘米)

吧台台面厚度: .5

吧台台面工作深度: 11.88英寸 (30.18厘米)

脚轮: 5英寸 (2个带锁, 2个不带锁)

外立面材料: 威尔逊艺术层压板

冰井深度: 9英寸 (22.86厘米)

冰井长度: 18英寸 (45.72厘米)

冰井宽度: 13英寸 (33.02厘米)

操作员工作区域深度: 25英寸 (63.50厘米)

操作员工作区域长度: 64.75英寸 (164.47厘米)

产品形状: 长方形

产品类型: 便携式酒吧

货架宽度: 32.75英寸 (83.19厘米)

高速铁路深度: 3.63英寸 (9.22厘米)

高速铁路长度: 22英寸 (55.88厘米)

高速铁路宽度: 4英寸 (10.16厘米)

标准配件: 带盖和球阀的保温不锈钢冰槽, 可拆卸式导轨

保修单: 1年

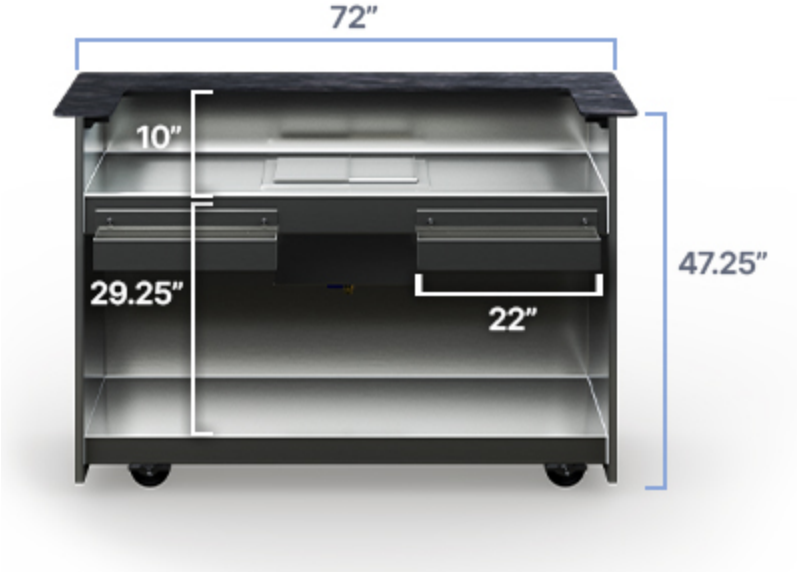

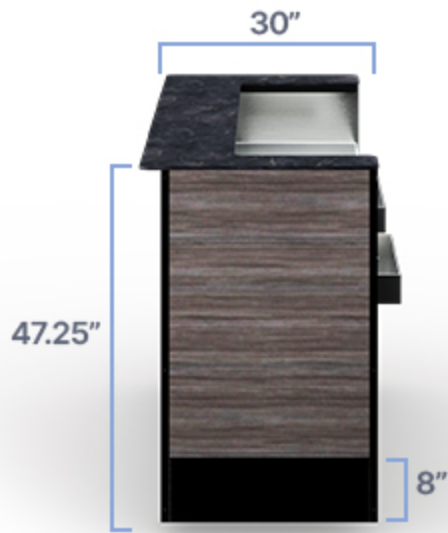

选项

吧台台面选项

致密层压板



第五大道榆树

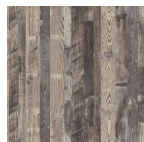

古董马鲁拉松木



米木

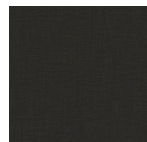

黑鸟

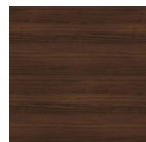

哥伦比亚核桃

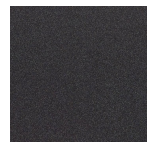

石墨星云



木兰

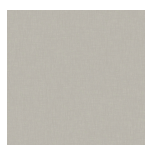

蘑菇

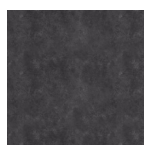

油浸皂石



公园榆树



珍珠皂石



门廊柚木

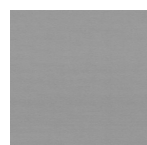

缎面不锈钢



天际胡桃木



柚木工作室

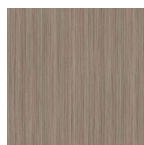

阳台柚木



白色谷仓

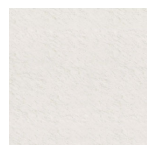

白色卡拉拉

Thinscape



匠心编织



黑阿玛尼

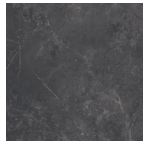

博斯科奥斯库罗

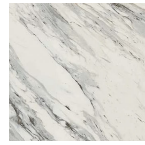

加尔各答白

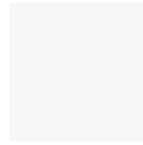

云雾



海岸编织



余烬桉树



埃蒂莫埃浓缩咖啡



金岸柚木

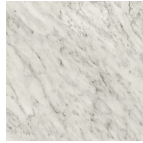

意大利卡拉拉



午间宫殿



迷雾灰

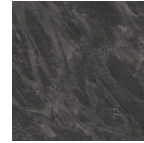

夜黑

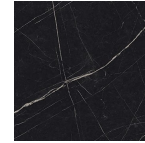

黑石



沙砾樱桃



海线迷雾



宁静编织



阴影网



皂石雾

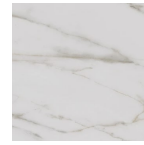

索伦纳大理石



索卢纳



西班牙石灰石



斯特林加尔各答



阳光下的橡树



泰姬陵



都市格子



沃拉卡斯大理石

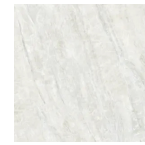

亚穆纳石英岩

立面选项



第五大道榆树



古董马鲁拉松木



匠心编织



米木

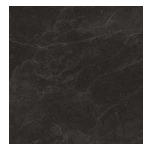

黑阿玛尼

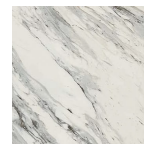

加尔各答白

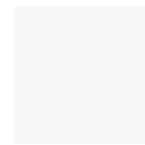

云雾



海岸编织

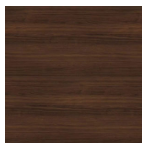

哥伦比亚核桃

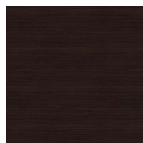

黑檀侦察兵

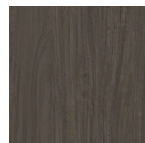

余烬桉树

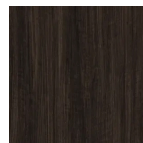

埃蒂莫埃浓缩咖啡



金岸柚木



石墨星云



马达加斯加



木兰



迷雾灰



蘑菇

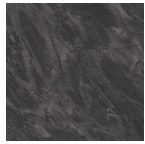

夜黑

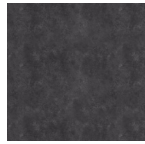

油浸皂石



帕利塞兹橡树



公园榆树



珍珠皂石



门廊柚木



沙砾樱桃

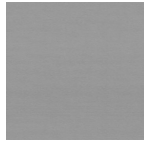

缎面不锈钢



海线迷雾



宁静编织



阴影网



天际胡桃木

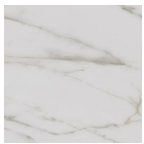

索伦纳大理石

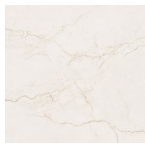

索卢纳



西班牙石灰石



阳光下的橡树



都市格子



阳台柚木

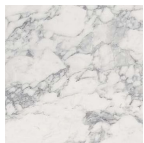

沃拉卡斯大理石



白色谷仓

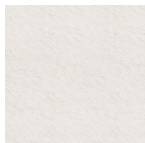

白色卡拉拉



野樱桃

升级 - 金属层压板



缎面拉丝黑铝



缎面拉丝金铝



缎面拉丝中青铜色铝



缎面拉丝天然铝



缎面拉丝烟熏铝

装饰饰面

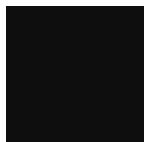

黑沙



拉丝不锈钢

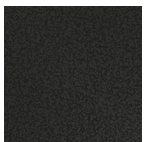

炭黑锤纹



Java

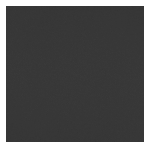

锡沙



缎面镍



银沙

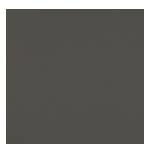

钨砂



城市青铜