

MITYLITE®

Imara Mobile Bar



CARACTÉRISTIQUES

Hauteur: 47,25" (120,02 cm)

Largeur: 32,75" (83,19 cm)

Longueur: 72" (182,88 cm)

Poids: 475 lbs (215,46 kg)

Profondeur du comptoir: 30" (76,20 cm)

Matériau pour comptoir de bar: Thinscape, stratifié compact

Largeur de retour du plateau de bar: 7" (17,78 cm)

Épaisseur du plateau de bar: .5

Profondeur de travail du comptoir de bar: 11,88" (30,18 cm)

Roulettes: 5" (2 verrouillables, 2 non verrouillables)

Matériau de façade: Stratifié Wilsonart

Profondeur du puits de glace: 9" (22,86 cm)

Longueur du puits de glace: 18" (45,72 cm)

Largeur du puits de glace: 13" (33,02 cm)

Profondeur de la zone de travail de l'opérateur: 25" (63,50 cm)

Longueur de la zone de travail de l'opérateur: 64,75" (164,47 cm)

Forme du produit: Rectangle

Type de produit: Bar portable

Largeur de l'étagère: 32,75" (83,19 cm)

Profondeur du train à grande vitesse: 3,63" (9,22 cm)

Longueur du train à grande vitesse: 22" (55,88 cm)

Largeur du rail à grande vitesse: 4" (10,16 cm)

Accessoires standard: Bac à glace isolé en acier inoxydable avec couvercle et vanne à bille, rails de vitesse amovibles

Garantie: 1 an

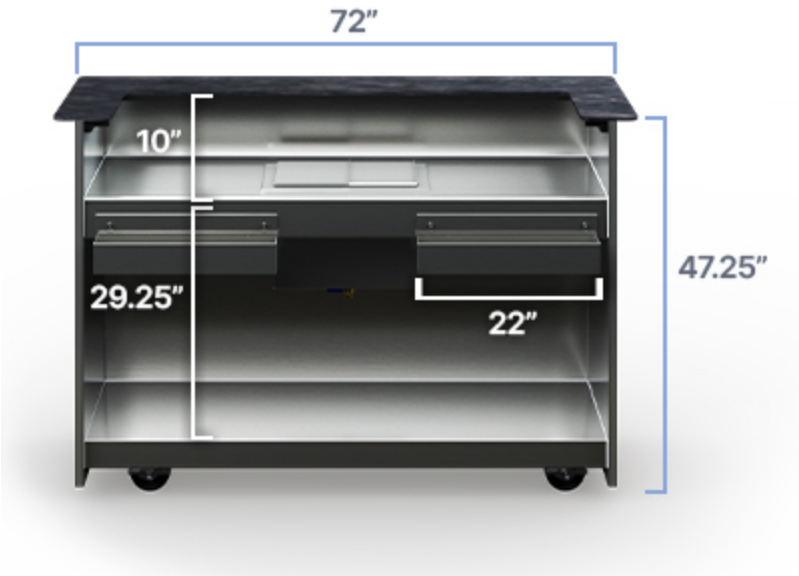

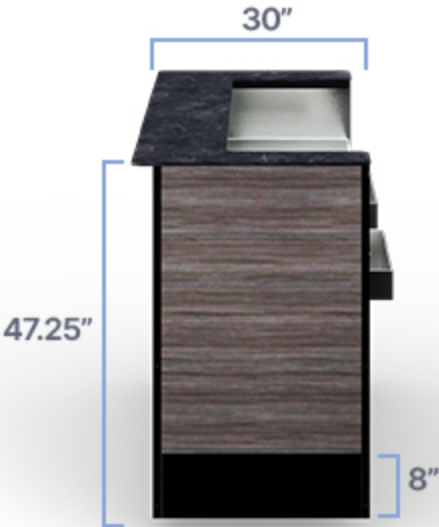

OPTIONS

OPTIONS DE COMPTOIR DE BAR

Stratifié compact



Orme de la 5e Avenue

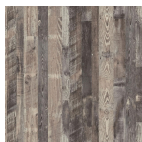

Pin marula ancien



Bois beige

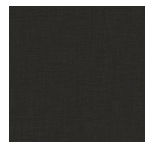

Merle

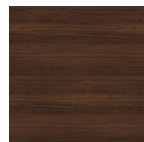

Noyer de Colombie

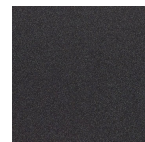

Nébuleuse du graphite



Magnolia

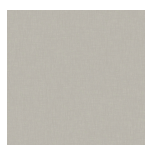

Champignon

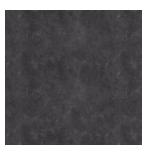

Stéatite huilée

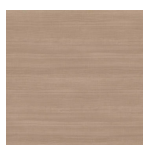

Orme du parc



Pierre à savon nacrée



Portique en teck

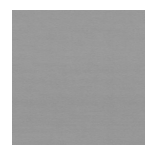

Acier inoxydable satiné



Skyline Walnut



Studio Teak

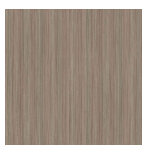

Véranda en teck



Grange Blanche

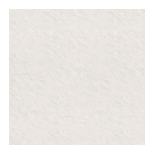

Carrare blanc

Thinscape

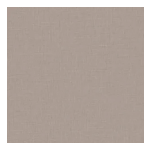

Tissage artisanal

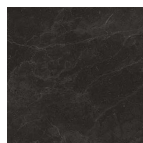

Amani noir

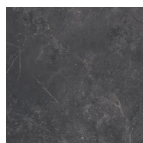

Bosco Oscuro

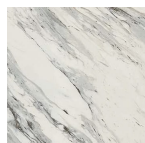

Calcutta Blanc

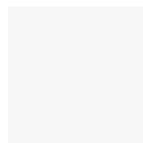

Nuages filés

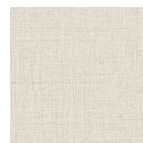

Tissage côtier

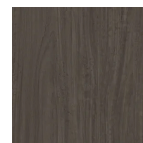

Eucalyptus braisé

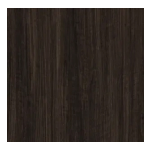

Espresso Etimoe

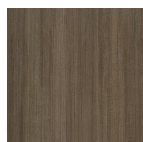

Teck des rivages dorés

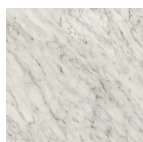

Carrare italienne

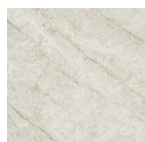

Mahal de midi



Gris du Mistral

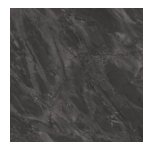

Notte Nera

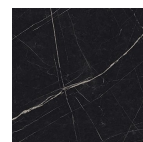

Pietra Noir



Cerise des sables

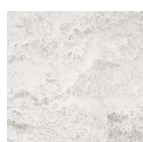

Brume de la ligne de mer

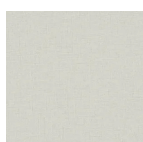

Tissage serein

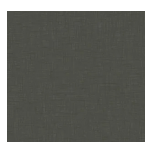

Toile d'ombre

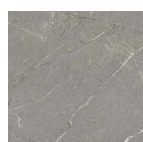

Brume de stéatite

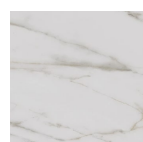

Marbre Solenne

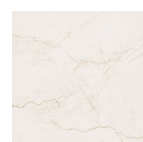

Soluna

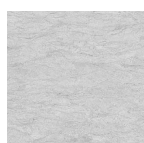

Calcaire espagnol

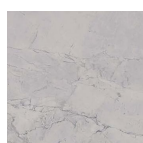

Sterling Calcutta



Chêne baigné de soleil

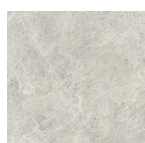

Taj Mahal



Treillis urbain

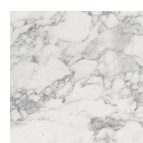

Marbre de Volakas

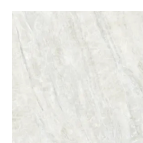

Quartzite de Yamuna

OPTIONS DE FAÇADE

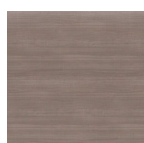

Orme de la 5e Avenue

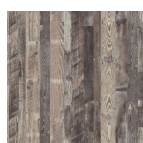

Pin marula ancien

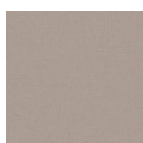

Tissage artisanal

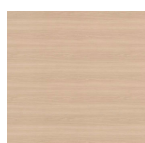

Bois beige

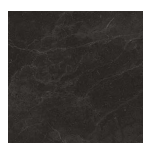

Amani noir

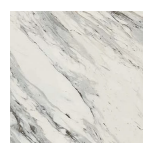

Calcutta Blanc

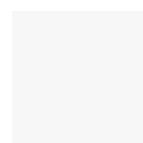

Nuages filés

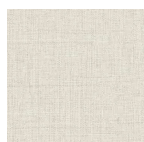

Tissage côtier

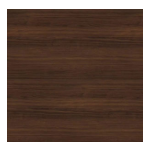

Noyer de Colombie

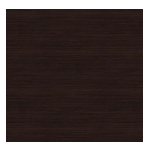

Reconnaissance d'ébène

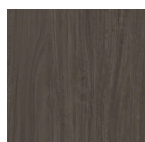

Eucalyptus braisé

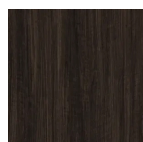

Espresso Etimoe

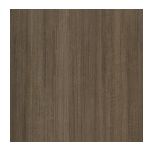

Teck des rivages dorés



Nébuleuse du graphite

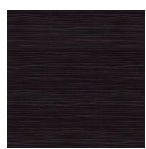

Madagascar



Magnolia



Gris du
Mistral

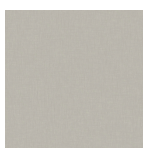

Champignon

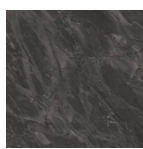

Notte Nera



Stéatite huilée



Chêne des
palissades



Orme du parc



Pierre à
savon nacrée

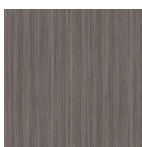

Portique en
teck

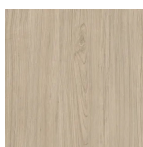

Cerise des
sables



Acier
inoxydable
satiné



Brume de la
ligne de mer



Tissage
serein



Toile d'ombre



Skyline
Walnut

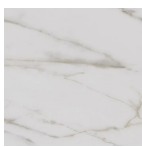

Marbre
Solenne

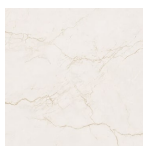

Soluna

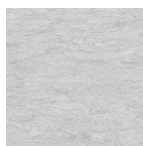

Calcaire
espagnol

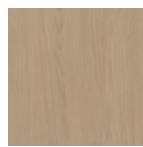

Chêne baigné
de soleil



Treillis urbain



Véranda en
teck



Marbre de
Volakas



Grange
Blanche

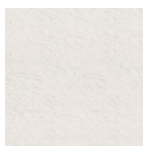

Carrare blanc

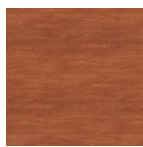

Cerise
sauvage

Amélioration - Stratifié métallique



Aluminium
noir brossé
satiné



Aluminium
doré brossé
satiné

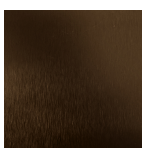

Aluminium
bronze moyen
brossé satiné



Aluminium
naturel brossé
satiné



Aluminium
fumé brossé
satiné

FINITIONS D'ACCENT



Sable noir



Acier
inoxydable
brossé

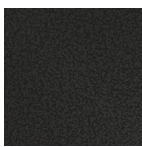

Charbon
martelé



Java



Sable d'étain



Nickel satiné



Silver Sand



sable de tungstène



Bronze urbain